

HOMELAND VINYL PROFILES

ITEM KEY EXPLANATION

COLOR CODES

W - White
T - Tan

Y - Honey Maple
O - Mocha Walnut

D - Adobe
G - Gray* (See Below)

Q - Earl Gray
U - Green Teak

INVENTORY CODES

F54U
Profile
Code

W
Color
Code

064
Length
in Inches

346
Pieces
per Bundle

Refer to profile sheet to obtain the profile code for the product you are ordering. Always review your order confirmation with descriptions to ensure order accuracy.

All special orders must ship once completed leaving NO backorders.

When ordering a length that is fractional, use the following list to determine the proper code for the length you require.

1/4" - A	3/8" - E
1/2" - B	5/8" - F
3/4" - C	7/8" - G
1/8" - D	11/16" - H

Example: 64-1/2" would be 64B

*GRAY PROFILES WILL NOT BE OFFERED AFTER 2015

Gray can only be ordered in the following profiles & lengths in 2015:

F10E - 5" x 5" post .135 wall (9')
F37C - 1-3/4" x 5-1/2" Gorilla Pocket Rail (94")
F54U - 7/8" x 6" Utility T & G (64" & 16')
F57C - 7/8" x 3" Standard Picket (16')
FFS7 - 2" x 7" Sun Pocket Rail (94")
F3P2 - 2" x 7" Nexus Pocket Rail (94")
F24E - 2" x 3-1/2" Utility Rail (16')
F83S - 7/8" U-Channel (10'2")

*All gray orders are considered special orders.
Stock will not be produced in any gray profiles.*

FABRICATION GUIDELINES

**Homeland Vinyl Products does not warranty bowing of pickets.
Please make sure of proper installation to reduce all of the factors mentioned.**

- Follow proper installation instructions.
- We recommend metal stiffeners in all rails for the Homewood series of product.
- Make sure that the metal stiffener is in the correct orientation.
- Make sure all rails are notched.
- We recommend attaching the U channel trim to the post to help stabilize T&G boards.
- Do not use any clear wrapping or shrink wrap on fence for storage or transportation. Make sure any wrap or protection of the fence or profiles does not absorb and retain heat. It will cause warping.
- We recommend the use of a midrail to reduce T&G bowing, especially on darker colors.
- Product expansion and contraction is temperature dependent and will vary more in longer lengths and darker colors. Please take this into account during installation.
- Do not store or install product next to a heat source.
- Be mindful of installing the product near reflective surfaces (E.G. glass windows and doors), which can concentrate sunlight and heat the product.
- Be mindful of installing the product on or adjacent to asphalt or similar materials that absorb heat.
- As with any other product, scratches will be more evident in darker colors. Use caution when transporting and installing the Homewood series of products.
- Make sure rail ends have at least 1 inch clearance of each other when inserted into posts for 6' lengths, and at least a 1 1/2 inch clearance into posts on 8' length rails. This will allow for adequate expansion and contraction of rails within the posts and prevent bow.
- Do not put dirt or mulch against rails. It could cause rails to permanently bow out.
- CAUTION - when dealing with slopes, please make sure that there is adequate clearance for T&G boards inside of the rail. If the T&G is binding against the rail, it will cause excessive bowing with expansion and contraction. Make sure pickets are cut for adequate clearance.

ROUND COLUMN PROFILES

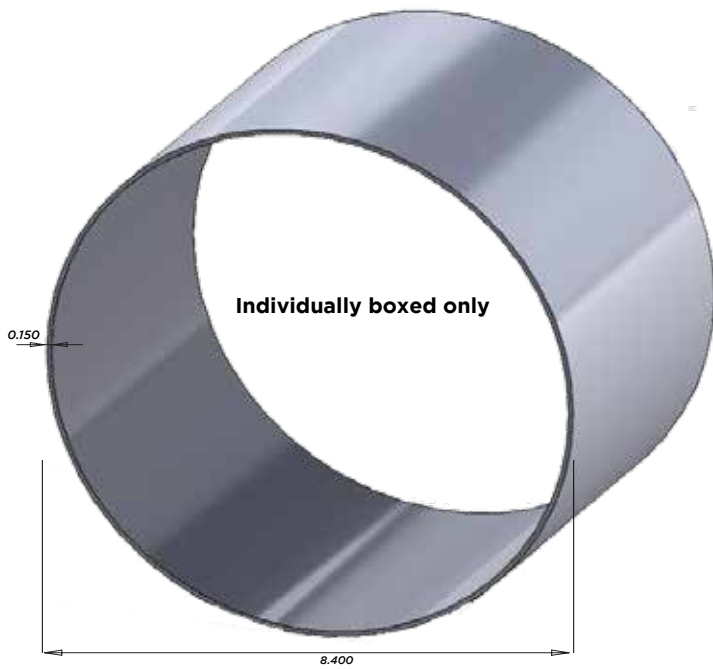

TD84 (0.150 wall)
8.40" Round Column
Pcs/Box: 1
Boxes/Skid: 10
SOLD IN SKID QUANTITIES ONLY
AL - 9'

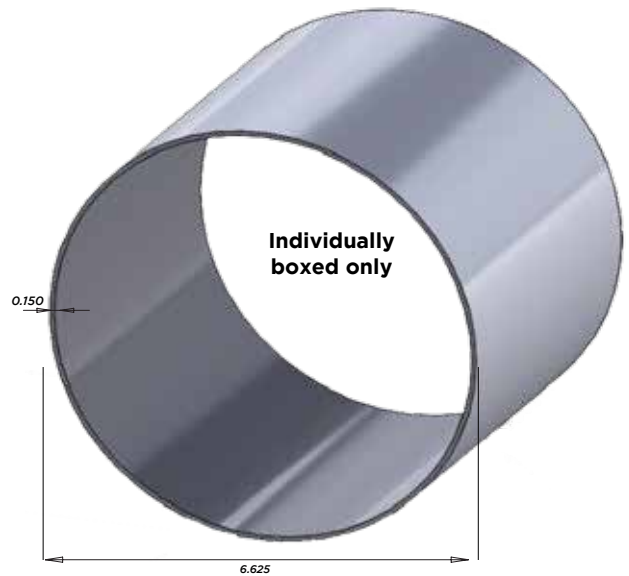

TD64 (0.150 wall)
6.625" Round Column
Pcs/Box: 1
Boxes/Skid: 20
SOLD IN SKID QUANTITIES ONLY
AL - 9'

*W=White, T=Tan, D=Adobe
Availability and profile dimensions are subject to change without notice. Check with manufacturer before ordering.
All dimensions are subject to manufacturer's tolerances.

Toll Free: (800) 999-6813



www.homelandvinyl.com

Rel. 15-131

POST PROFILES

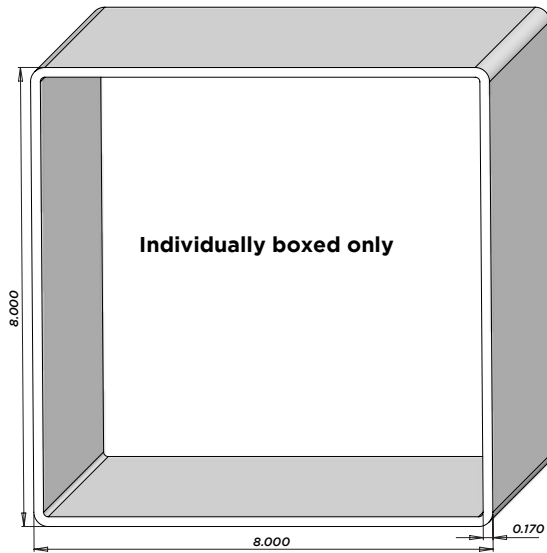

F06C (0.170 wall)
8"x8" Standard Post
Pcs/Box: 1
Boxes/Skids: 10
SOLD IN SKID
QUANTITIES ONLY
AL - 9'
NJ - NA
UT - NA

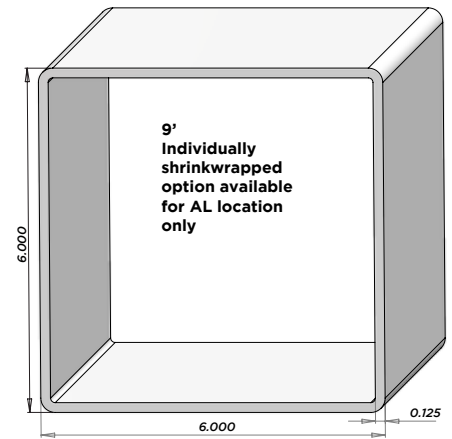

F09C (0.125 wall)
6"x6" Standard Post
Pcs/Pallet: 56
AL - 9', 10', 16'
NJ - 9', 16'
UT - NA

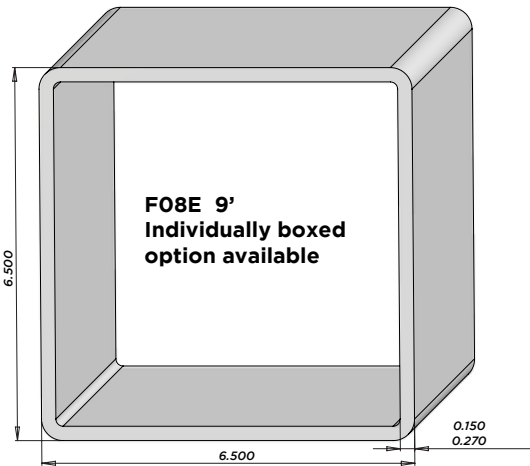

F08S (0.270 wall)
6-1/2"x6-1/2" Gorilla® Post
Pcs/Pallet: 21
AL - 9', 16', 24'
NJ - NA
UT - NA

F08E (0.150 wall)
6-1/2"x6-1/2" Post
Pcs/Pallet: 49
(16' & 24', 21 pcs.)
AL - 9', 16', 24'
NJ - NA
UT - NA

Boxed Option for F08E & F10E:
Pcs/Box: 1 Boxes/Skids: 20
SOLD IN SKID QUANTITIES ONLY

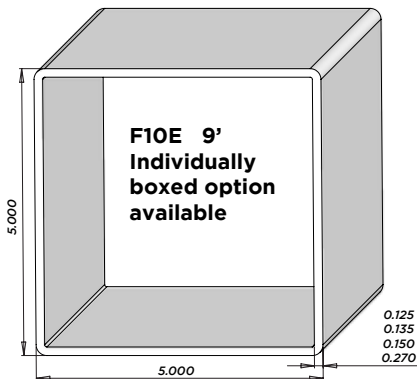

F10K (0.270 wall)
5"x5" Gorilla® Post
Pcs/Pallet: 36
AL - 9', 16', 24'
NJ - 9', 16'
UT - NA

F10E (0.135 wall)
5"x5" Utility Post
Pcs/Pallet: 81 (16', 24', 36 pcs.)
AL - 7', 8', 9', 16', 24'
NJ - 7', 8', 9', 16', 24'
UT - 7', 8', 9', 16', 24'

F10C (0.150 wall)
5"x5" Standard Post
Pcs/Pallet: 81 (16', 24', 36 pcs)
AL - 7', 8', 9', 16', 24'
NJ - 7', 8', 9', 16', 24'
UT - 7', 8', 9', 16', 24'

F10J (0.125 wall)
5"x5" Utility Ranch Post
(Color Inside)
Pcs/Pallet: 81
AL - 5', 6' 6", 7'
NJ - NA
UT - 6' 6", 7'

*W=White, T=Tan, D=Adobe
 Availability and profile dimensions are subject to change without notice. Check with manufacturer before ordering.
 All dimensions are subject to manufacturer's tolerances.

POST PROFILES

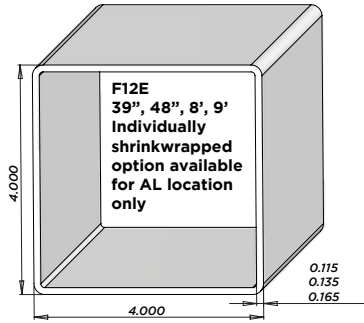

F12C (0.165 wall)
4"x4" Gorilla® Post
Pcs/Pallet: 121 (16', 24', 55 pcs.)
AL - 8', 9', 16', 24'
NJ - NA
UT - 16'

F12E (0.115 wall)
4"x4" Utility Post
Pcs/Pallet: 121 (16', 24', 55 pcs.)
AL - 39", 48", 7', 8', 9', 16', 24'
NJ - 39", 48", 7', 8', 9', 16', 24'
UT - 8', 9', 16', 24'

F12N (0.135 wall)
4"x4" Standard Post
Pcs/Pallet: 121 (16', 24', 55 pcs.)
AL - 8', 9', 16', 24'
NJ - 8', 9', 16', 24'
UT - 8', 9', 16', 24'

F12V (0.115 wall)
4"x4" Value Post (Color Inside)
Pcs/Pallet: 55
AL - NA
NJ - 38", 8'
UT - NA

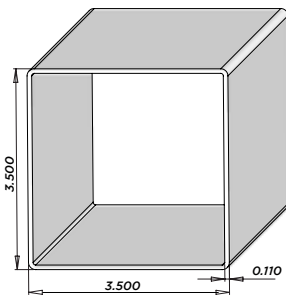

F13E (0.110 wall)
3-1/2"x3-1/2" Utility Post
Pcs/Pallet: 156 (16' - 78 pcs.)
AL - 6', 8', 16'
NJ - NA
UT - 16'

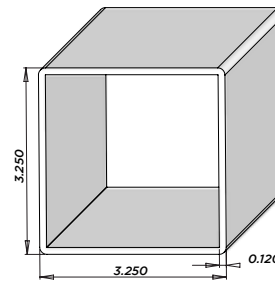

F15S (0.120 wall)
3-1/4"x3-1/4" Standard Post
Pcs/Pallet: 98
AL - 16'
NJ - NA
UT - NA

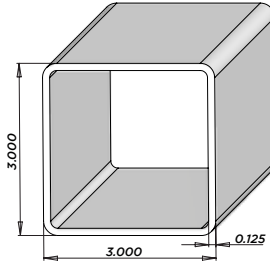

F14C (0.125 wall)
3"x3" Co-Ex Standard Post
Pcs/Pallet: 120
AL - 16', 24'
NJ - NA
UT - NA

*W=White, T=Tan, D=Adobe
 Availability and profile dimensions are subject to change without notice. Check with manufacturer before ordering.
 All dimensions are subject to manufacturer's tolerances.

POCKET RAIL PROFILES

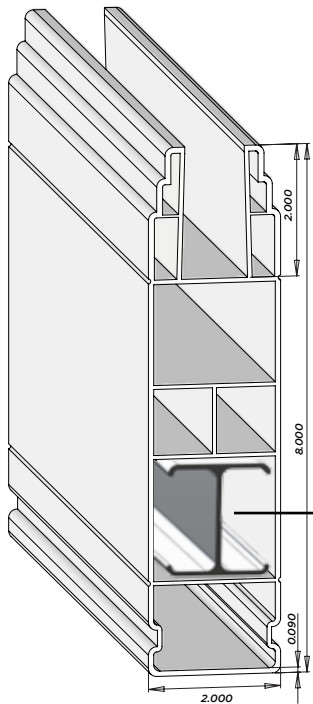

F3P8
2"x8" Nexus® Pocket Rail
7/8" x 2" Deep - Patent Pending
Pcs/Pallet: 55
AL - 82-1/2", 94"
NJ - NA
UT - NA

Proper G3P2 Aluminum
 Insert Orientation Shown

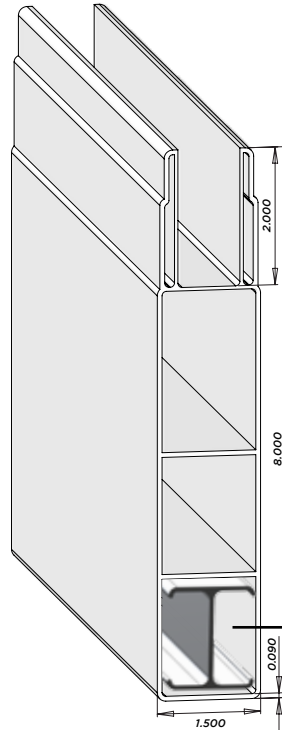

F3P1
1-1/2" x8" Gorilla® Pocket Rail
7/8" x 2" Deep
Pcs/Pallet: 72
AL - NA
NJ - NA
UT - 76", 83", 88", 94", 16'

Proper G32GP Aluminum
 Insert Orientation Shown

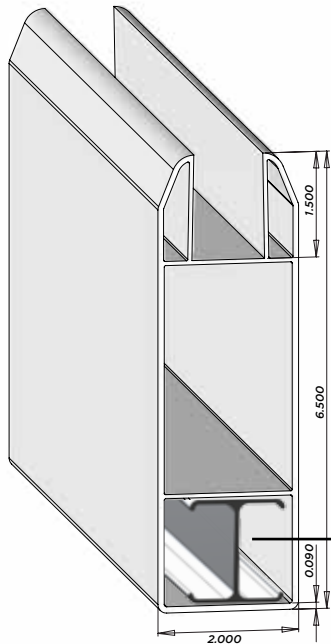

F31S
2"x7" Railmaster 1" Pocket Rail
1" x 1 3/4" Deep
Pcs/Pallet: 79
AL - NA
NJ - NA
UT - 8', 16'

Proper G3P2 Aluminum
 Insert Orientation Shown

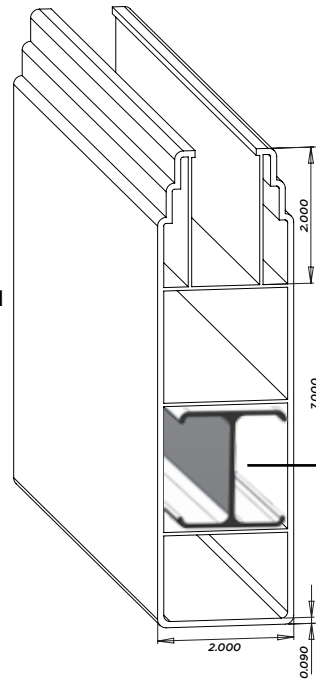

FFS7
2"x7" Sun Pocket Rail
7/8" x 2" Deep
Pcs/Pallet: 66
AL - NA
NJ - 94", 94 1/2", 12', 16'
UT - NA

Proper G3P2 Aluminum
 Insert Orientation Shown

*W=White, T=Tan, D=Adobe
 Availability and profile dimensions are subject to change without notice. Check with manufacturer before ordering.
 All dimensions are subject to manufacturer's tolerances.

POCKET RAIL PROFILES

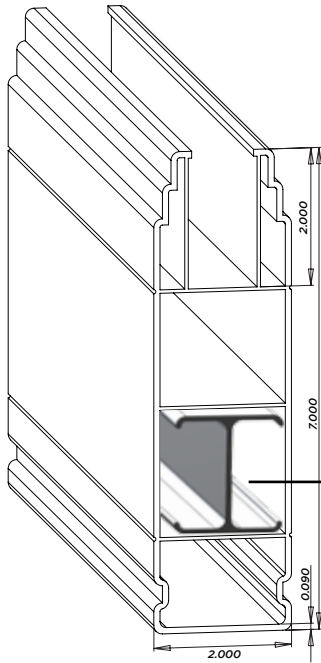

F3P2
2"x7" Nexus® Pocket Rail
7/8" x 2" Deep - Patent Pending
Pcs/Pallet: 66
AL - 71-1/2", 94", 16'
NJ - NA
UT - NA

Proper G3P2 Aluminum
 Insert Orientation Shown

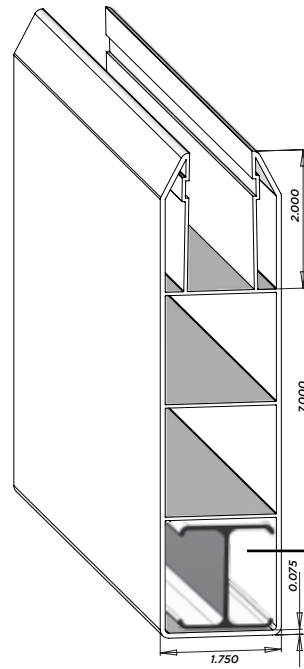

F3P7
1-3/4"x7" Nexus® Pocket Rail
7/8" x 2" Deep - Patent Pending
Pcs/Pallet: 72
AL - 94", 16'
NJ - NA
UT - NA

Proper G32GP Aluminum
 Insert Orientation Shown

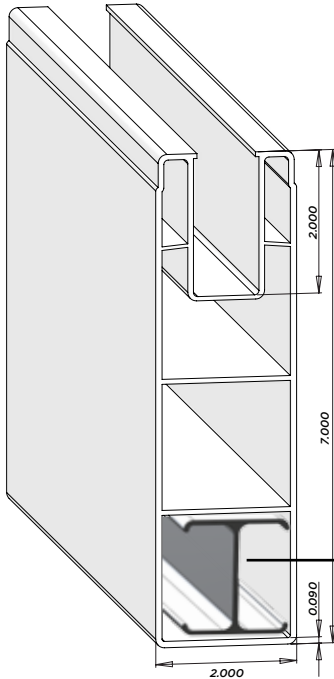

F3BF
2"x 7" Gorilla® Pocket Rail
7/8" x 2" Deep
Pcs/Pallet: 66
AL - NA
NJ - 94", 95", 16'
UT - NA

Proper G3P2 Aluminum
 Insert Orientation Shown

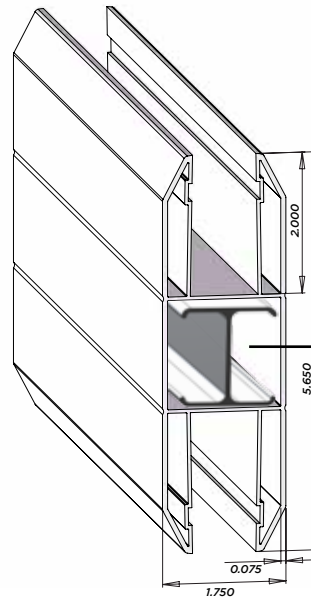

F3PM
1-3/4"x5-1/2" Nexus® Mid-Rail
7/8" x 2" Deep - Patent Pending
Pcs/Pallet: 98
AL - 71-1/2", 94", 16'
NJ - NA
UT - 71-1/2", 94", 16'

Proper G32GP Aluminum
 Insert Orientation Shown

*W=White, T=Tan, D=Adobe

Availability and profile dimensions are subject to change without notice. Check with manufacturer before ordering.
 All dimensions are subject to manufacturer's tolerances.

POCKET RAIL PROFILES

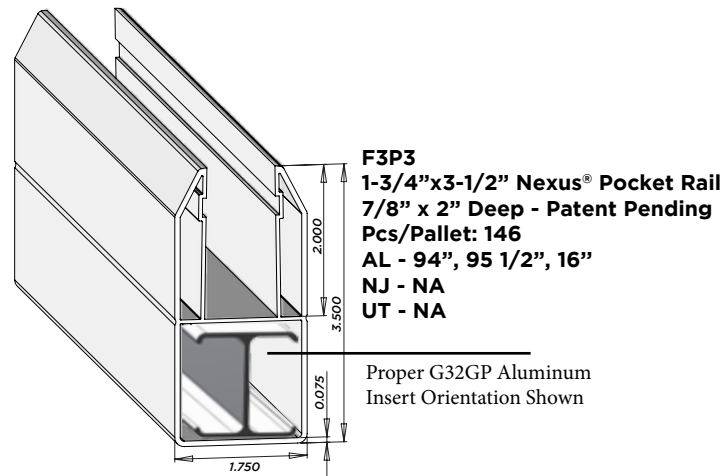
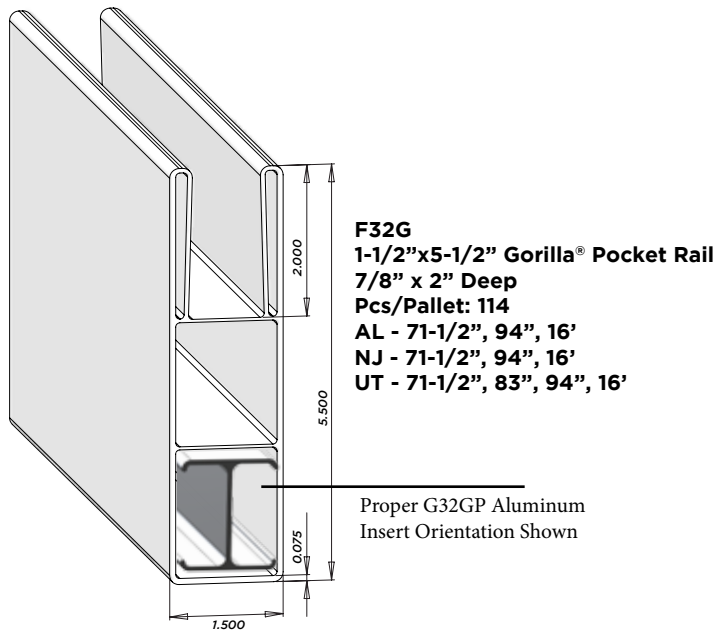
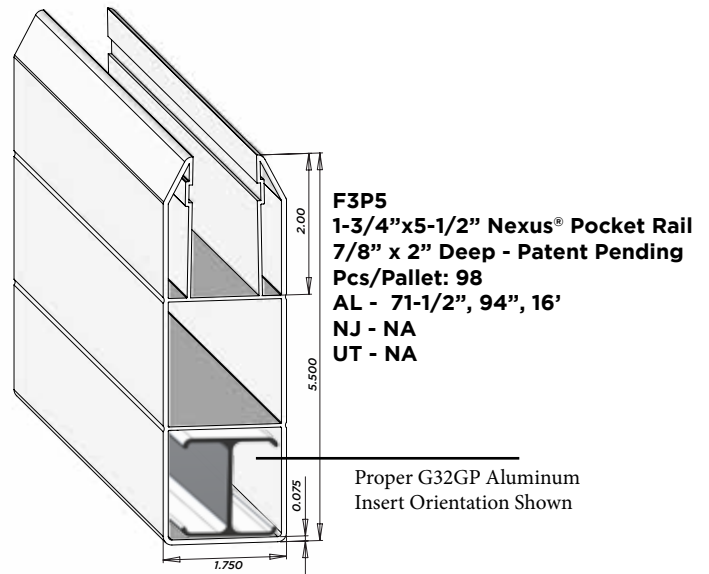
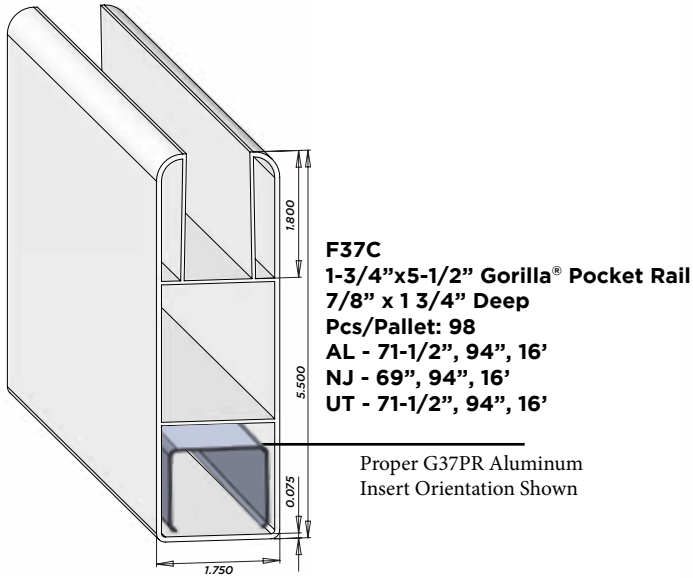

*W=White, T=Tan, D=Adobe
 Availability and profile dimensions are subject to change without notice. Check with manufacturer before ordering.
 All dimensions are subject to manufacturer's tolerances.

Toll Free: (800) 999-6813



www.homelandvinyl.com

Rel. 15-042

PRIVACY PICKET PROFILES

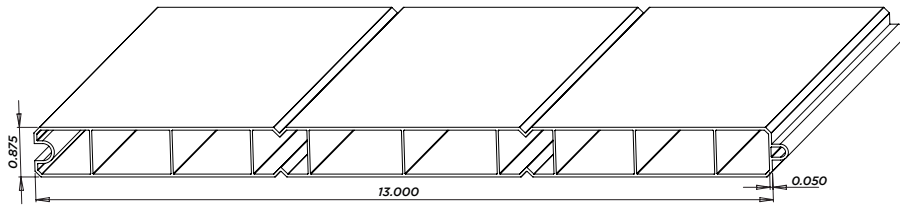

F60S (0.050 wall)
 7/8" x 13" T&G Standard
 AL - 16' (78 Pcs/Pallet)
 NJ - NA
 UT - 16' (100 Pcs/Pallet)

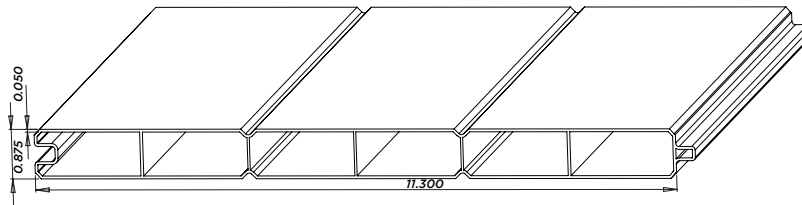

F61S (0.050 wall)
 7/8" x 11.3" T&G Standard
 Pcs/Pallet: 100
 AL - 60", 62-1/4" (208 Pcs/Pallet),
 16' (100 Pcs/Pallet)
 NJ - NA
 UT - 55-1/4", 60-1/4", 62-1/4", 64",
 16' (100 Pcs/Pallet)

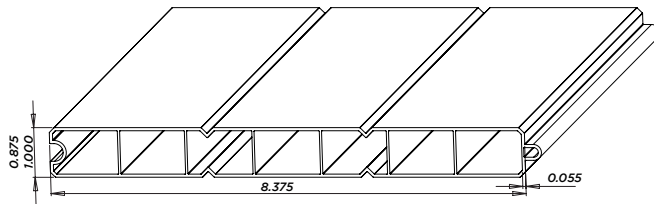

F51R (0.055 wall)
 1"x8-3/8" Ribbed T&G
 Pcs/Pallet: 109
 (Short Lengths 224 Pcs/Pallet)
 AL - NA
 NJ - NA
 UT - 60", 16'

F50C (0.055 wall)
 7/8"x8-3/8" Ribbed T&G
 Pcs/Pallet: 119
 AL - 16'
 NJ - NA
 UT - NA

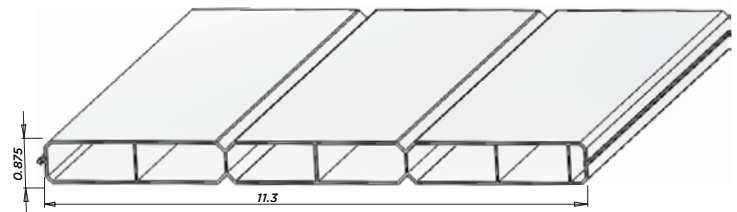

F61L (0.050 wall)
 7/8"x11.3" Locking Panel
 Pcs/Pallet: 100
 UT - 16'
 AL - NA
 NJ - NA

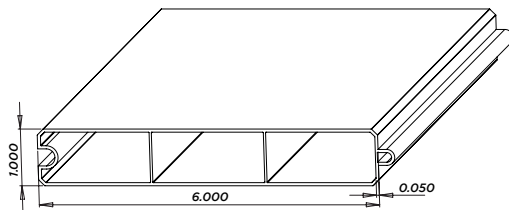

F52U (0.050 wall)
 1"x6" T&G Standard
 Pcs/Pallet: 350 (16'-166 Pcs/Pallet)
 AL - NA
 NJ - NA
 UT - 60", 16'

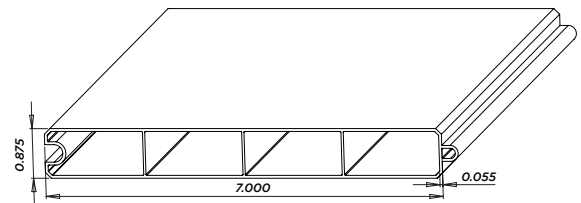

F62S (0.055 wall)
 7/8"x 7 " T&G Utility
 Pcs/Pallet: 148 (16'),
 Shorter Lengths, 292
 AL - NA
 NJ - 32-1/2", 44-1/2", 60", 61", 15', 16'
 UT - N/A

*W=White, T=Tan, D=Adobe
 Availability and profile dimensions are subject to change without notice. Check with manufacturer before ordering.
 All dimensions are subject to manufacturer's tolerances.

Toll Free: (800) 999-6813



www.homelandvinyl.com

PRIVACY PICKET PROFILES

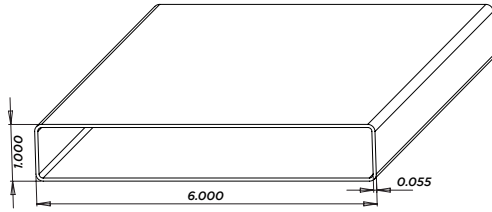

F53S (0.055 wall)
1"x6" Hollow Utility
Pcs/Pallet: 176
AL - NA
NJ - NA
UT - 16'

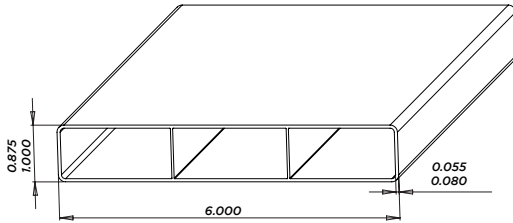

F53U (0.080 wall)
1"x6" Utility Ribbed
Pcs/Pallet: 176
AL - NA
NJ - NA
UT - 16'

F56R (0.055 wall)
7/8"x6" Ribbed Standard
Pcs/Pallet: 178
AL - 16'
NJ - 16'
UT - 16'

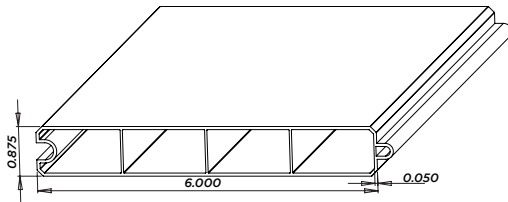

F54U (0.050 wall)
7/8"x6" T&G Utility
Pcs/Pallet: 178 (16'),
Shorter Lengths, 346
AL - 48", 52", 60", 61", 62-1/4", 64", 16'
NJ - 48", 52", 60", 61", 62-1/4", 64", 16'
UT - 48", 60-1/4", 62-1/4", 16'

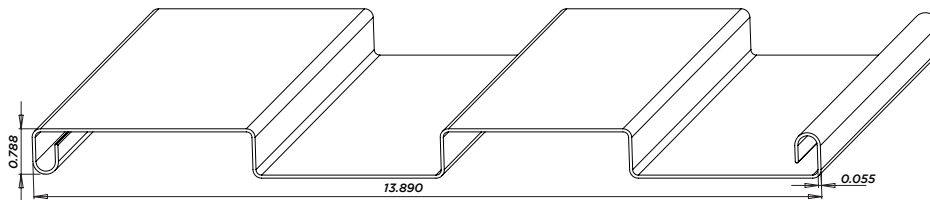

F55B (0.055 wall)
7/8" x 14" Privacy No Emboss Panel
Pcs/Pallet: 96
AL - 29", 64", 12'6"
NJ - NA
UT - NA

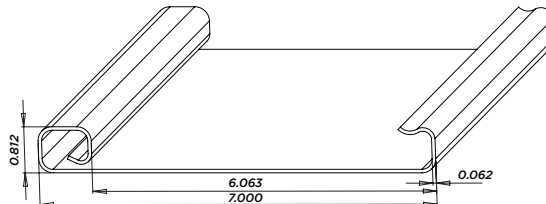

F55N (0.062 wall)
7/8" x 6" Privacy Snap Panel
Pcs/Pallet: 312
AL - 62-1/4", 16'
NJ - NA
UT - NA

*W=White, T=Tan, D=Adobe
 Availability and profile dimensions are subject to change without notice. Check with manufacturer before ordering.
 All dimensions are subject to manufacturer's tolerances.

SPECIALTY PRODUCTS PROFILES

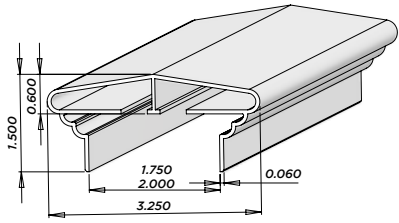

1-3/4" Rail Crown®
F38A
Pcs/Box: 20
AL - 12'
NJ - N/A
UT - N/A

2" Rail Crown®
F38S
Pcs/Box: 20
AL - 12'
NJ - N/A
UT - N/A

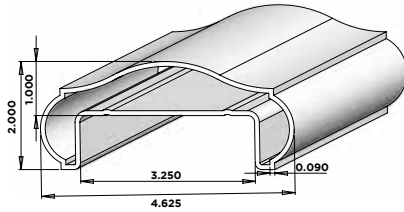

3-1/4" Rail Cap
F39S
Pieces: 90
AL - 16'
NJ - N/A
UT - N/A



Modulus® ADA
Aluminum Joiner
G33JN
8' each

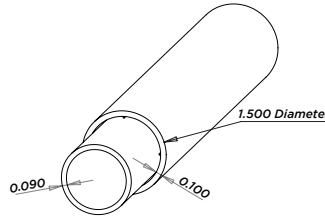

Modulus® ADA Grab Rail
with Aluminum Insert
F33A
AL - Bulk: 16'1"
(75 pcs per Pallet)

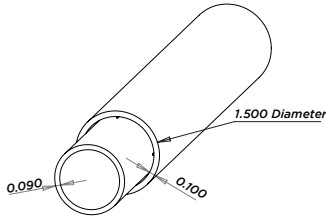

Modulus® ADA Grab Rail
with Aluminum Insert
(Sleeved)
F33C
Pcs/Box: 8
AL - 8'8"

*W=White, T=Tan, D=Adobe

Check for color availability at each plant.

Availability and profile dimensions are subject to change without notice. Check with manufacturer before ordering.

All dimensions are subject to manufacturer's tolerances.

RAIL CROWN & CAP

ADA RAILING

Toll Free: (800) 999-6813



www.homelandvinyl.com

Rel. 15-131

SPECIALTY PRODUCTS PROFILES

U & LATTICE CHANNELS

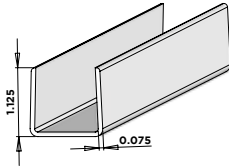

1" U-Channel Standard
F82S
Pcs/Box: 64
AL - 10'2"
NJ - N/A
UT - 10'2"

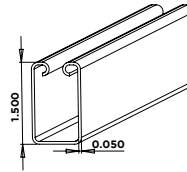

1-1/2" Lattice Channel
F88S
Pcs/Box: 32
AL - 8'
NJ - N/A
UT - N/A

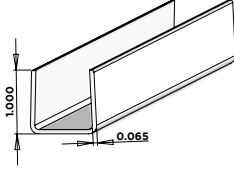

7/8" U-Channel Standard
F83S
Pcs/Box: 64 (10' 2")
(Shorter lengths
1280 Pcs/Pallet)
AL - 10'2", 60-7/8"
NJ - 10'2"
UT - N/A

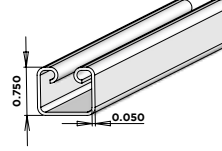

3/4" Lattice Channel
F89S
Pcs/Box: 60
AL - 8'
NJ - N/A
UT - N/A

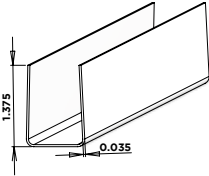

7/8" Trim Channel
F83U
Pcs/Box: 60 (10' 2")
(Shorter lengths
840 Pcs/Pallet)
AL - 10'2", 58-3/4", 59-1/4", 60-7/8"
NJ - N/A
UT - 10'2", 57", 58-3/4", 52", 59"

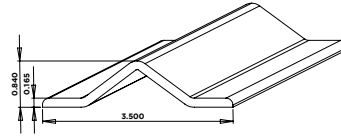

Gate Support Rail
F86S
Pcs/Box: 24
AL - 8', 12'
NJ - N/A
UT - N/A

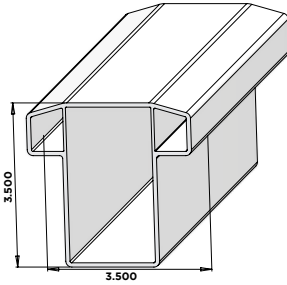

3-1/2" Gorilla® T-Rail
(0.09 wall)
F35C
Pcs/Pallet: 90
AL - 6', 8', 10', 16'
NJ - 6', 8', 10', 16'
UT - N/A

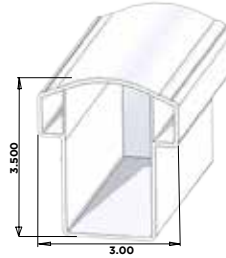

3" Contour Rail (.095 wall)
F36S
Pcs/Pallet: 102
AL - 6', 8', 10', 24'
NJ - NA
UT - NA

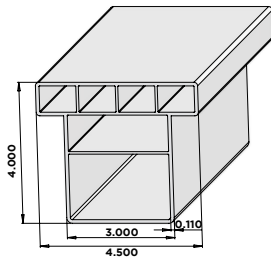

4-1/2" Gorilla® Rail
FTB
Pcs/Pallet: 66
AL - 24'
NJ - N/A
UT - N/A

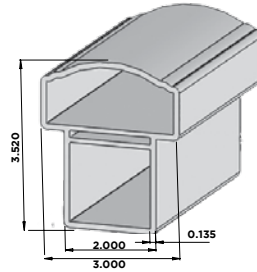

3" Bread Loaf
FTR
Pcs/Pallet: 102
AL - 24'
NJ - NA
UT - NA

RAILING

*W=White, T=Tan, D=Adobe

Check for color availability at each plant.

Availability and profile dimensions are subject to change without notice. Check with manufacturer before ordering.

All dimensions are subject to manufacturer's tolerances.

Toll Free: (800) 999-6813



www.homelandvinyl.com

Rel. 15-131

RAIL PROFILES

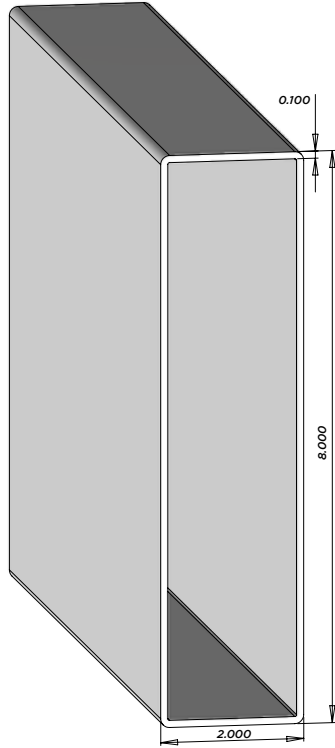

F20S
2" X 8" Hollow Rail
Pcs/Pallet: 66
AL - 16', 24'
NJ - NA
UT - 16' 24'

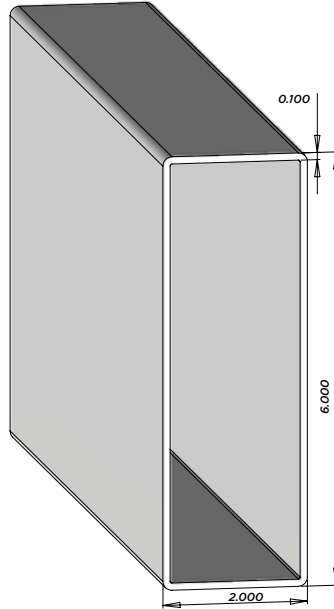

F22E
2"x6" Hollow Rail
Pcs/Pallet: 88
AL - 12', 16', 24'
NJ - NA
UT - 12', 16', 24'

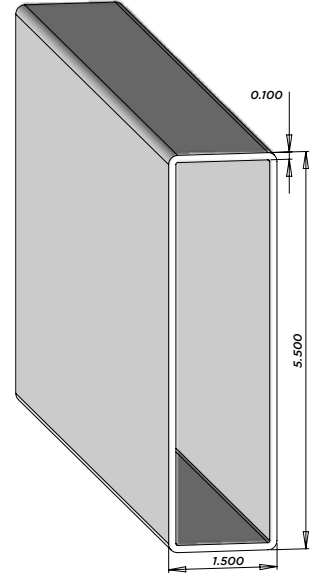

F27S
1-1/2"x5-1/2" Hollow Rail
Pcs/Pallet: 114
AL - 16'
NJ - NA
UT - NA

Special order only
Minimum order required

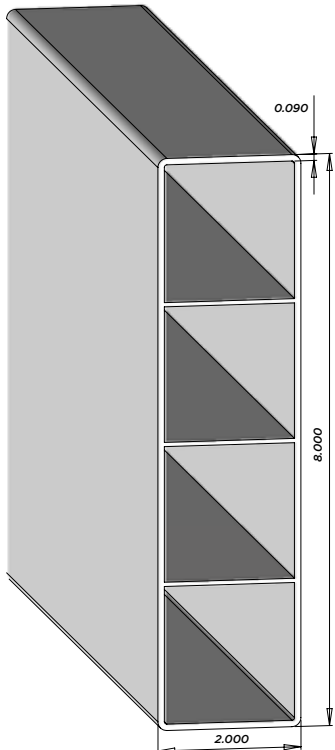

F20R
2"x8" Ribbed Rail
Pcs/Pallet: 66
AL - 16', 24'
NJ - NA
UT - NA

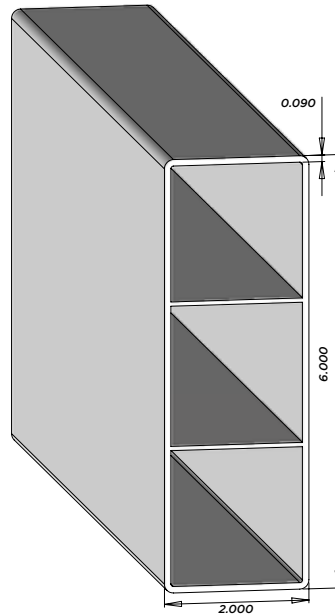

F22C
2"x6" Ribbed Rail
Pcs/Pallet: 88
AL - 8', 12', 16'
NJ - 16'
UT - 12', 16', 24'

*W=White, T=Tan, D=Adobe
 Availability and profile dimensions are subject to change without notice. Check with manufacturer before ordering.
 All dimensions are subject to manufacturer's tolerances.

RAIL PROFILES

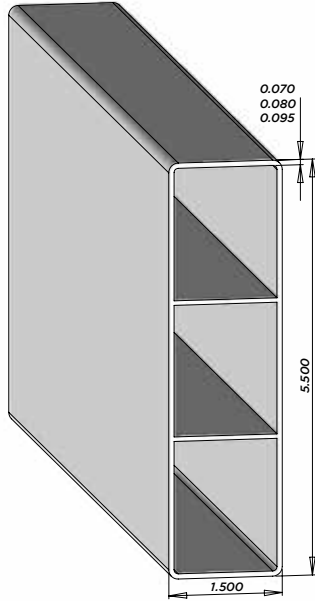

F27C (0.095 Wall)
 1-1/2"x5-1/2" Ribbed Rail
 Pcs/Pallet: 114
 AL - 16'
 NJ - NA
 UT - 16'

F27E (0.080 Wall)
 1-1/2"x5-1/2" Ribbed Utility Rail
 Pcs/Pallet: 114
 AL - 16'
 NJ - 94", 16'
 UT - 16'

F27M (0.070 Wall)
 1-1/2"x5-1/2" Utility Value Rail
 (Color Inside)
 Pcs/Pallet: 114
 AL - 16'
 NJ - NA
 UT - 16'

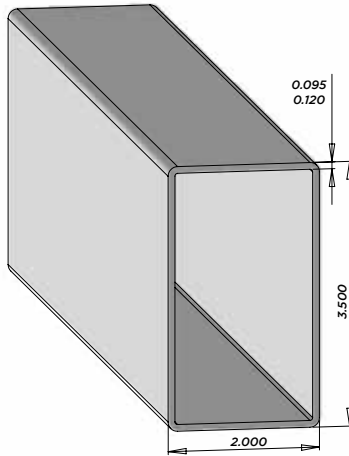

F24C (0.120 Wall)
 2"x3-1/2" Hollow Standard Rail
 Pcs/Pallet: 143
 AL - 6', 8', 12', 16', 24'
 NJ - NA
 UT - 6', 8', 12', 16'

F24E (0.095 Wall)
 2"x3-1/2" Hollow Utility Rail
 Pcs/Pallet: 143
 AL - 6', 8', 94", 10', 12', 16', 24'
 NJ - 6', 94", 8', 10', 16'
 UT - 8', 12', 16'

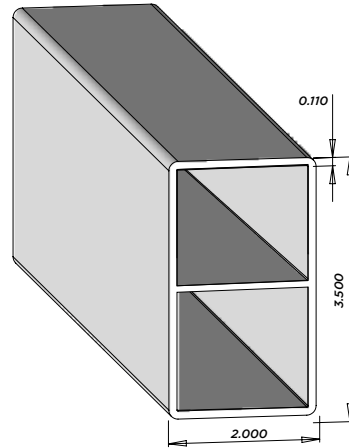

F24B
 2"x3-1/2" Ribbed Rail
 Pcs/Pallet: 143
 AL - 8', 16', 24'
 NJ - NA
 UT - 8', 16'

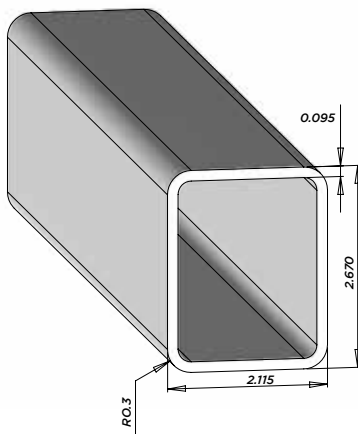

F26S
 2-1/8" x 2-3/4" Standard Rail
 Pcs/Pallet: 170
 AL - 70-3/4", 94-3/4", 16'
 NJ - NA
 UT - NA

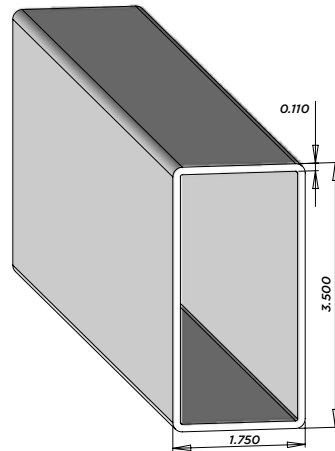

F25B
 1-3/4"x3-1/2" Hollow Standard Rail
 Pcs/Pallet: 156
 AL - 16'
 NJ - NA
 UT - 16'

*W=White, T=Tan, D=Adobe
 Availability and profile dimensions are subject to change without notice. Check with manufacturer before ordering.
 All dimensions are subject to manufacturer's tolerances.

RAIL PROFILES

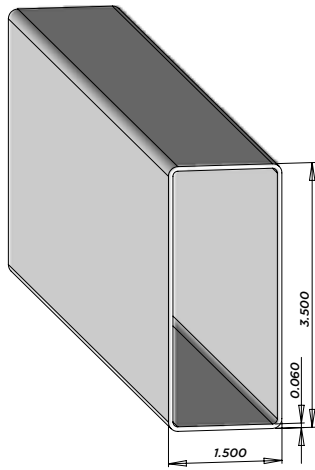

F28S
1-1/2" x 3-1/2" Standard Rail
Pcs/Pallet: 182
AL - NA
NJ - NA
UT - 57-1/2"

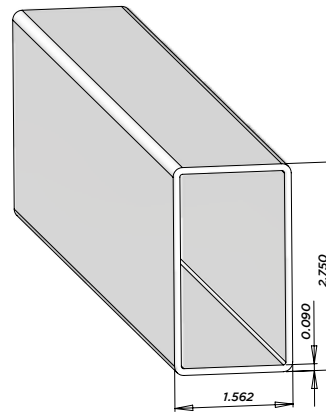

F23S
1-1/2" x 2-3/4" Standard Rail
Pcs/Pallet: 224
AL - 16'
NJ - NA
UT - NA

*W=White, T=Tan, D=Adobe
Availability and profile dimensions are subject to change without notice. Check with manufacturer before ordering.
All dimensions are subject to manufacturer's tolerances.

Toll Free: (800) 999-6813



www.homelandvinyl.com

Rel. 14-335

PICKET PROFILES

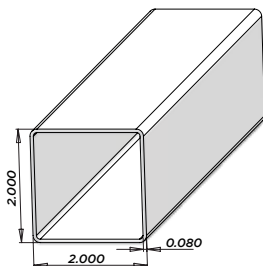

F40S (0.080 Wall)
2"x2" Standard Pickets
Pcs/Pallet: 230
AL - 16'
NJ - NA
UT - NA

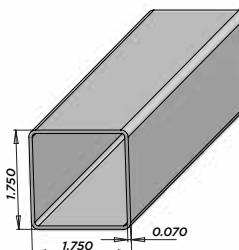

F41S (0.070 Wall)
1-3/4"x1-3/4" Standard Pickets
Pcs/Pallet: 312
AL - 16'
NJ - NA
UT - 16'

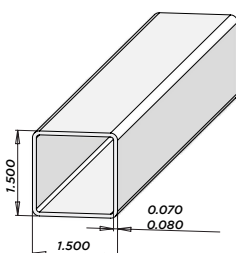

F42H (0.080 Wall)
1-1/2"x1-1/2" Gorilla® Pickets
Pcs/Pallet: 450
AL - 16'
NJ - NA
UT - 16'

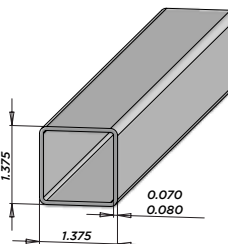

F43H (0.080 Wall)
1-3/8"x1-3/8" Gorilla® Pickets
Pcs/Pallet: 330
AL - 16'
NJ - 16'
UT - 16'

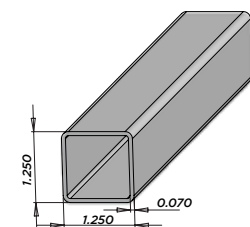

F44S (0.070 Wall)
1-1/4"x1-1/4" Standard Pickets
Pcs/Pallet: 350
AL - 16', 32" (1225/pallet)
NJ - NA
UT - 16'

F43C (0.070 Wall)
1-3/8"x1-3/8" Standard Pickets
Pcs/Pallet: 600 (16', 330 pcs.)
AL - 16', 32", 38-1/2"
NJ - 16', 30"
UT - 16'

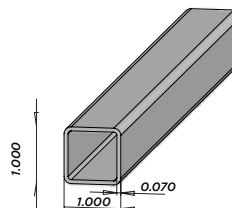

F45S (0.070 Wall)
1"x1" Standard Pickets
Pcs/Pallet: 450
AL - 16'
NJ - NA
UT - 16'

*W=White, T=Tan, D=Adobe

Availability and profile dimensions are subject to change without notice. Check with manufacturer before ordering.
 All dimensions are subject to manufacturer's tolerances.

PICKET PROFILES

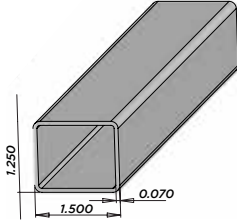

F47S (0.070 Wall)
1-1/4"x1-1/2" Standard Pickets
Pcs/Pallet: 510
AL - 16'
NJ - NA
UT - NA

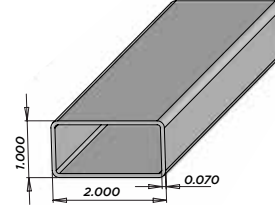

F48S (0.070 Wall)
1"x2" Standard Pickets
Pcs/Pallet: 270
AL - 16'
NJ - NA
UT - 16'

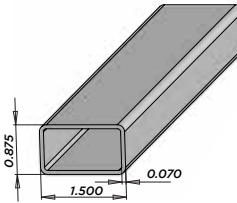

F65S (0.070 Wall)
7/8"x1-1/2" Standard Pickets
Pcs/Pallet: 402
AL - 16'
NJ - 16'
UT - 16'

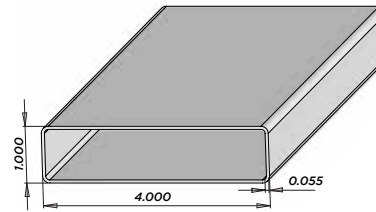

F49U (0.055 Wall)
1"x4" Utility Pickets
Pcs/Pallet: 253
AL - 16'
NJ - NA
UT - NA

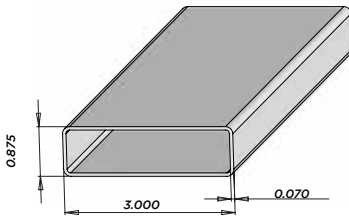

F57C (0.070 Wall)
7/8" X 3" Standard Pickets
Pcs/Pallet: 355
AL - 12', 16'
NJ - 45-7/8", 12', 16'
UT - 16'

*W=White, T=Tan, D=Adobe
 Availability and profile dimensions are subject to change without notice. Check with manufacturer before ordering.
 All dimensions are subject to manufacturer's tolerances.

GORILLA® WRAP PROFILES

GORILLA® Wrap 8 Piece Inserts used with the GORILLA® Wrap Corner

GORILLA® WRAP 8 PIECE

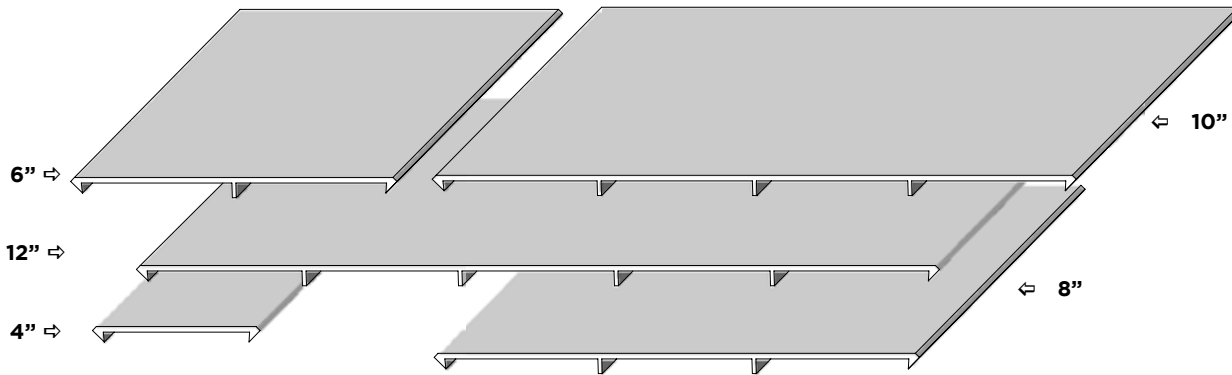

**4" Gorilla® Wrap Insert
FMW4**
Covers sides of 3 1/4" to 4 1/4"

**6" Gorilla® Wrap Insert
FMW6**
Covers sides of 5 1/4" to 6 1/4"

**8" Gorilla® Wrap Insert
FMW8**
Covers sides of 7 1/4" to 8 1/4"

**10" Gorilla® Wrap Insert
FMW0**
Covers sides of 9 1/4" to 10 1/4"

**12" Gorilla® Wrap Insert
FMW2**
Covers sides of 11 1/4" to 12 1/4"

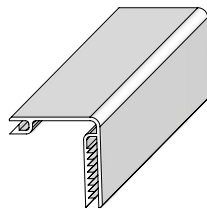

**Gorilla® Wrap Corner
FMWC**

All 8 piece Wrap Components Packaged 20 pcs/Box. Separately In 10' Lengths.

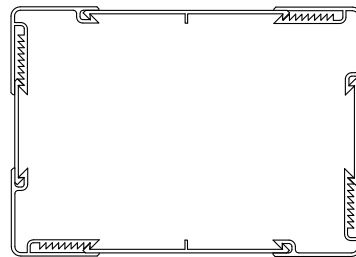
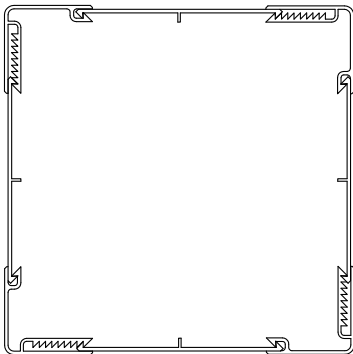

Various size inserts may be utilized

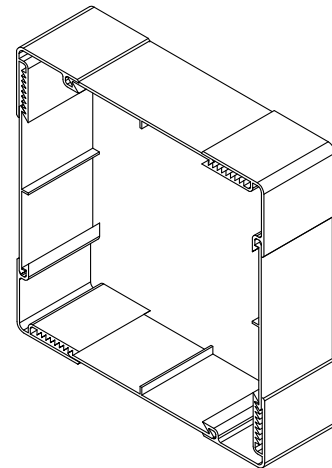

*W=White, T=Tan, D=Adobe

All components available from Alabama.

Availability and profile dimensions are subject to change without notice. Check with manufacturer before ordering.
All dimensions are subject to manufacturer's tolerances.

Toll Free: (800) 999-6813



www.homelandvinyl.com

Rel. 14-323

GORILLA® WRAP PROFILES

GORILLA® Wrap 4 Piece

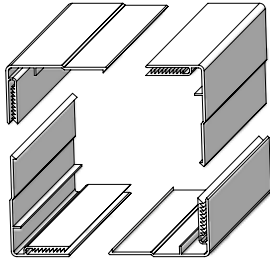

**4"x4" Gorilla® Wrap
FPW4**
Pcs/Box: 5 posts per box
Bulk: 92 posts per bundle
Length - 10'

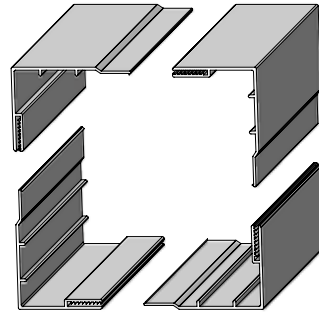

**6"x6" Gorilla® Wrap
FPW6**
Pcs/Box: 4 posts per box
Bulk: 74 posts per bundle
Length - 10'

GORILLA® WRAP 4 PIECE

*W=White, T=Tan, D=Adobe

All components available from Alabama.

Availability and profile dimensions are subject to change without notice. Check with manufacturer before ordering.
All dimensions are subject to manufacturer's tolerances.

Toll Free: (800) 999-6813



www.homelandvinyl.com

Rel. 14-323

ALUMINUM INSERTS PROFILES

5" x 5"
G10HA288-69243
 24' Lengths
 Per Piece

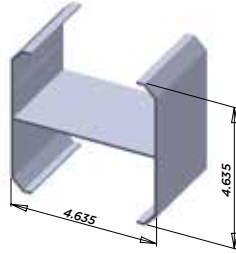

Pocket Rail & Nexus® Series
U Insert
G37PR093-40668
 93" Lengths
 286 Pieces per Bundle

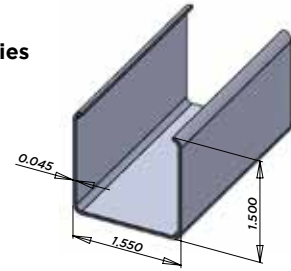

4" x 4"
G12HA288-69312
 24' Lengths
 Per Piece

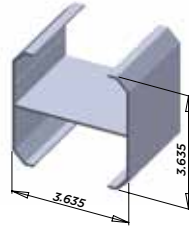

Gorilla & Breadloaf Rail
GTRAB288001
 24' Lengths
 Per Piece

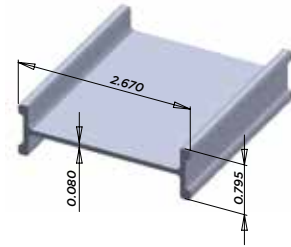

1-3/4" x 3-1/2"
G25PA288-69230
 24' Lengths
 Per Piece

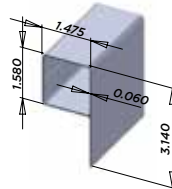

Nexus® 2" x 7" Pocket Rail
I Insert
G3P2093-7896
 93" Lengths
 250 Pieces per Bundle

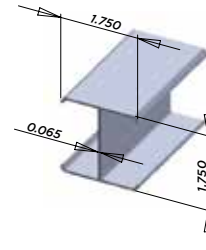

2-1/8" x 2-3/4" Down
G26CH288-69228
 24' Lengths
 Per Piece

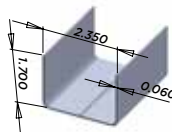

1-1/2" Aluminum "I" Insert
G32GP093-06505
 71", 93" Lengths
 300 Pieces per Bundle

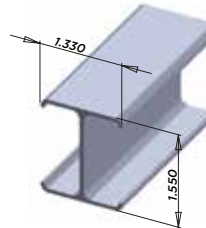

2-1/8" x 2-3/4" Up
G26CV288-69231
 24' Lengths
 Per Piece

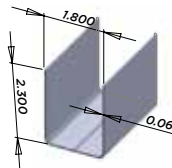

2" X 7" Keystone West Insert
GW7093-12710
 93" Lengths
 300 Pieces per Bundle

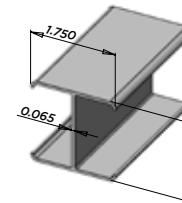

Availability and profile dimensions are subject to change without notice. Check with manufacturer before ordering.
 All dimensions are subject to manufacturer's tolerances.

ALUMINUM INSERTS PROFILES

2" x 3-1/2" & T-Rail
G24PA288-69227
24' Lengths
120 Pieces per Bundle

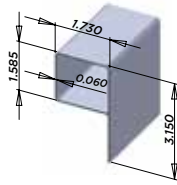

H-Rail
G24HA096-55026
96" Lengths
For top rail only
120 Pieces per Bundle

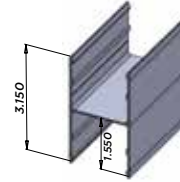

T-Bottom Rail
G24TA096-55028
72", 96" Lengths
For bottom rail only
120 Pieces per Bundle

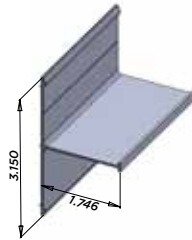

Small h
G24hA072-55027
72" Lengths
For top rail only
120 Pieces per Bundle

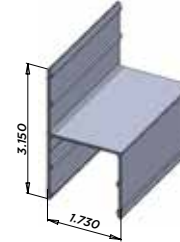

Availability and profile dimensions are subject to change without notice. Check with manufacturer before ordering.
All dimensions are subject to manufacturer's tolerances.

Toll Free: (800) 999-6813



www.homelandvinyl.com

Rel. 14-136

GORILLA DECK® PROFILES

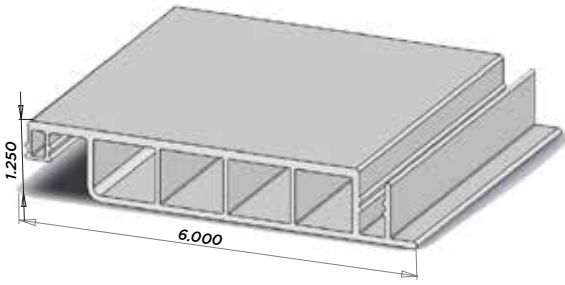

**Gorilla Deck® G3
F70E**
Patent #6,324,796
Pcs/Pallet: 49
AL - 16', 20', 24'

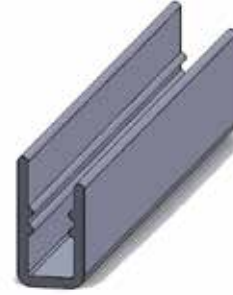

**Gorilla Deck®
Starter Strip
F73G**
Pcs/Box: 24
AL - 12'6"



**Gorilla Deck®
Splice Trim
F74G**
Pcs/box: 8
AL - 12'6"
*Use with Gorilla Deck only.

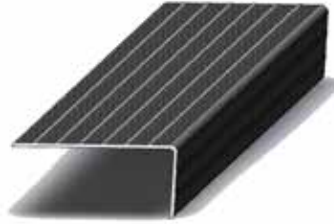

**Gorilla Deck®
Fascia Trim
F76G**
Pcs/box: 24
AL - 12'6"

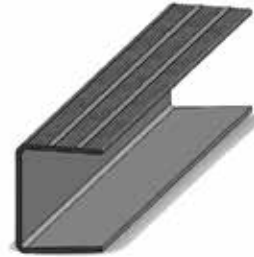

**Gorilla Deck®
Finish Trim
F75G**
Pcs/box: 20
AL - 12'6"

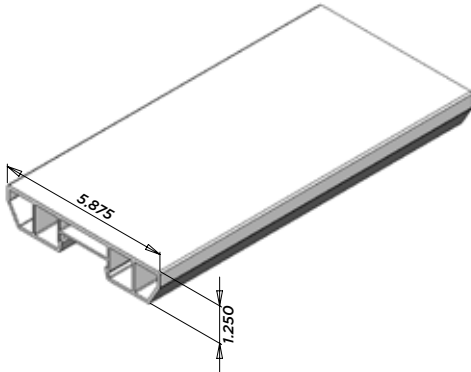

**Gorilla® Lock Deck
F71A**
Patent #6,594,961
Pcs/Pallet: 49
AL - 16', 20', 24'

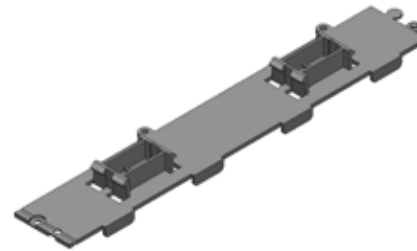

**Gorilla® Lock
Mounting Strip
12" Long
F71B**
Patent #6,594,961
Pcs/Box: 50

GORILLA DECK® FASCIA SYSTEM

Used with Gorilla® Wrap Inserts (White Tan & Adobe Only)

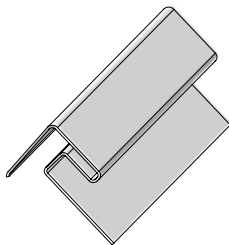

**Gorilla Deck®
Fascia Corner
F79G**
Pcs/box: 20
AL - 13"

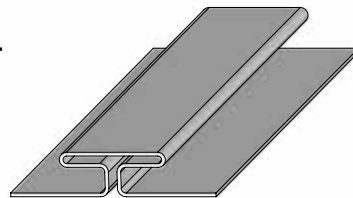

**Gorilla Deck®
Fascia Splice
F78G**
Pcs/box: 20
AL - 13"

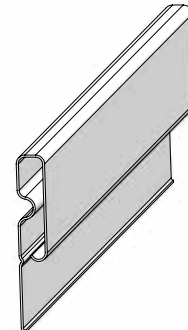

**Gorilla Deck®
Fascia Adapter
F77G**
Pcs/box: 20
AL - 10"

GORILLA DECK® G3, GORILLA® LOCK & ACCESSORIES ONLY SUPPLIED FROM ALABAMA PLANT

*W=White, D=Adobe, O=Mocha Walnut, Y=Honey Maple, Q=Earl Gray, U=Green Teak (Q & U - Coming Soon)
Availability and profile dimensions are subject to change without notice. Check with manufacturer before ordering.
All dimensions are subject to manufacturer's tolerances.

Toll Free: (800) 999-6813



www.homelandvinyl.com

Rel. 15-010

TUF-FENCE® PROFILES

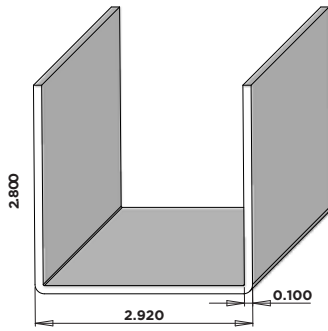

Tuf-Fence®
U-Channel (Long Leg)
FT03
6', 8'

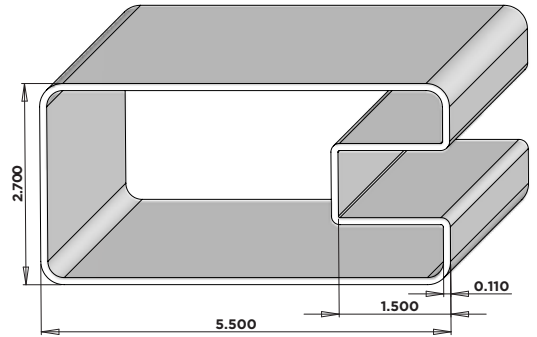

Tuf-Fence®
Pocket Rail
FT12
96.25"

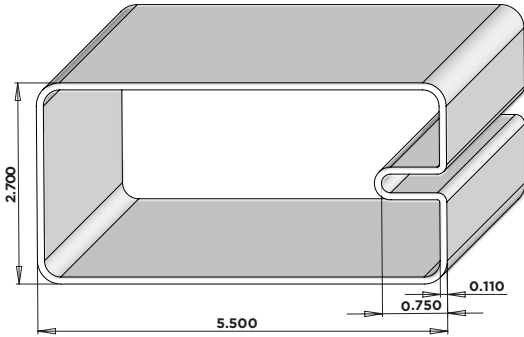

Tuf-Fence®
Lattice Top Rail
FT13
96.25"

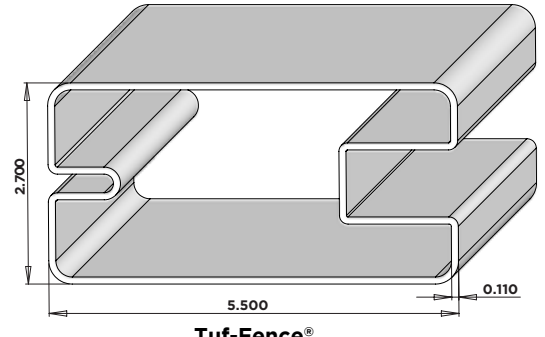

Tuf-Fence®
Mid-Rail
FT11
96.25"

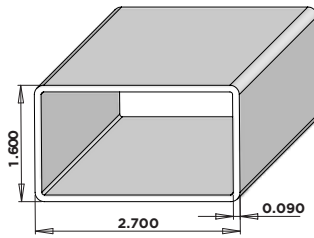

Tuf-Fence®
Insert for H-Post
FT02
8'

Tuf-Fence®
H-Post
FT01
7', 9', 10'

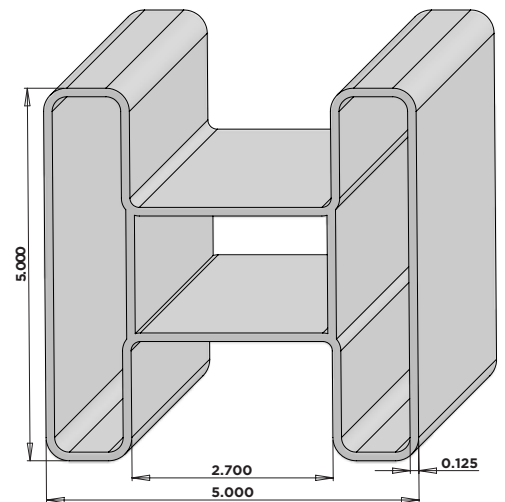

*W=White
 T=Tan
 D=Adobe
 Alabama Only

Availability and profile dimensions are subject to change without notice. Check with manufacturer before ordering.
 All dimensions are subject to manufacturer's tolerances.

HOMELAND[®] PROFILES

Homewood Fabrication Guidelines

Homeland Vinyl Products does not warranty bowing of pickets.
Please make sure of proper installation to reduce all of the factors mentioned.

- Follow proper installation instructions.
- We recommend metal stiffeners in all rails for the Homewood series of product.
- Make sure that the metal stiffener is in the correct orientation.
- Make sure all rails are notched.
- We recommend attaching the U channel trim to the post to help stabilize T&G boards.
- Do not use any clear wrapping or shrink wrap on fence for storage or transportation. Make sure any wrap or protection of the fence or profiles does not absorb and retain heat. It will cause warping.
- We recommend the use of a midrail to reduce T&G bowing, especially on darker colors.
- Product expansion and contraction is temperature dependent and will vary more in longer lengths and darker colors. Please take this into account during installation.
- Do not store or install product next to a heat source.
- Be mindful of installing the product near reflective surfaces (E.G. glass windows and doors), which can concentrate sunlight and heat the product.
- Be mindful of installing the product on or adjacent to asphalt or similar materials that absorb heat.
- As with any other product, scratches will be more evident in darker colors. Use caution when transporting and installing the Homewood series of products.
- Make sure rail ends have at least 1 inch clearance of each other when inserted into posts for 6' lengths, and at least a 1 1/2 inch clearance into posts on 8' length rails. This will allow for adequate expansion and contraction of rails within the posts and prevent bow.
- Do not put dirt or mulch against rails. It could cause rails to permanently bow out.
- CAUTION - when dealing with slopes, please make sure that there is adequate clearance for T&G boards inside of the rail. If the T&G is binding against the rail, it will cause excessive bowing with expansion and contraction. Make sure pickets are cut for adequate clearance.

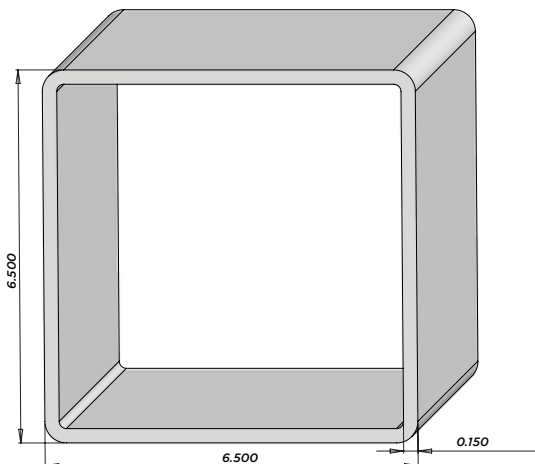

F08E (0.150 wall)
6-1/2"x6-1/2" Post
Pcs/Pallet: 49
AL - 9', 16'

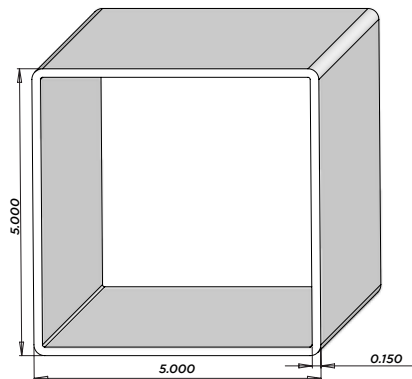

F10C (0.150 wall)
5"x5" Standard Post

Pcs/Pallet: 81 (9')
36 (16')
AL - 9', 16'
UT - 8', 16'

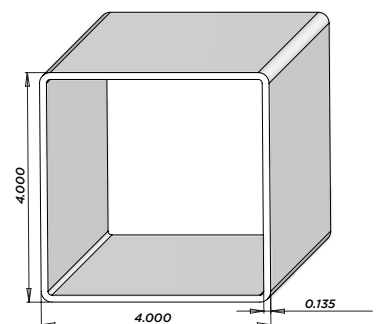

F12N (0.135 wall)
4"x4" Standard Post

Pcs/Pallet: 121 (6')
55 (16')
AL - 6', 16'
UT - 6', 16'

*O=Mocha Walnut, Y=Honey Maple, Q=Earl Gray, U=Green Teak (Q & U - Coming Soon)
Availability and profile dimensions are subject to change without notice. Check with manufacturer before ordering.
All dimensions are subject to manufacturer's tolerances.

Toll Free: (800) 999-6813



www.homelandvinyl.com

Rel. 15-131

GUARD RAIL HOMEWOOD® PROFILES

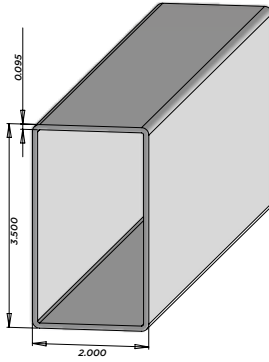

F24E (0.095 Wall)
2"x3-1/2" Hollow Standard Rail
(ER1 - AL only)

Pcs/Pallet: 143
AL - 72", 96"
UT - 72", 96"

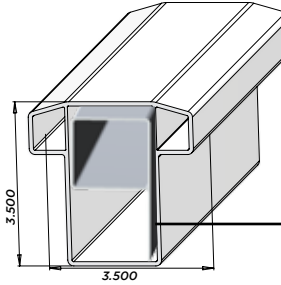

F35C (0.090 Wall)
3-1/2" Gorilla® T-Rail
(ER1 - AL only)

Pcs/Pallet: 90
AL - 72", 96"

Proper G24PA °Aluminum
Insert Orientation Shown

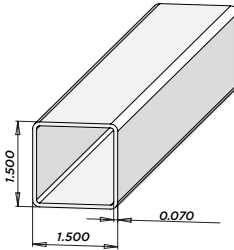

F42S (0.070 Wall)
1-1/2"x1-1/2" Standard Pickets
(ER1 - AL only)

Pcs/Pallet: 450 (16')
900 (32" & 38")
AL - 32", 38", 16'
UT - 16'

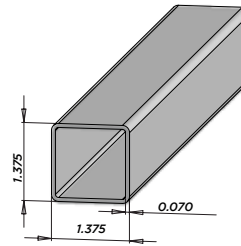

F43C (0.070 Wall)
1-3/8"x1-3/8" Standard Pickets
(ER1 - AL only)

Pcs/Pallet: 330 (16')
600 (32' & 38')
AL - 32", 38", 16'
UT - 16'

ALUMINUM INSERTS PROFILES

2" x 3-1/2" & T-Rail
G24PA288-69227
24' Lengths
120 Pieces per Bundle
Purchase Separately

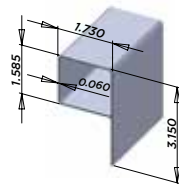

H-Rail
G24HA096-55026
96" Lengths
For top rail only
120 Pieces per Bundle
Purchase Separately

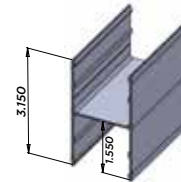

T-Bottom Rail
G24TA096-55028
72", 96" Lengths
For bottom rail only
120 Pieces per Bundle
Purchase Separately

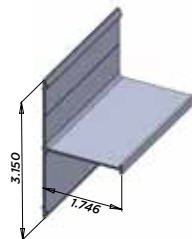

Small h
G24hA072-55027
72" Lengths
For top rail only
120 Pieces per Bundle
Purchase Separately

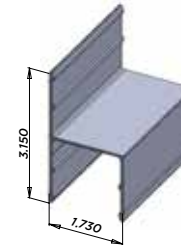

*O=Mocha Walnut, Y=Honey Maple, Q=Earl Gray, U=Green Teak (Q & U - Coming Soon)
Availability and profile dimensions are subject to change without notice. Check with manufacturer before ordering.
All dimensions are subject to manufacturer's tolerances.

Toll Free: (800) 999-6813



www.homelandvinyl.com

Rel. 15-131

HOMELAND® PROFILES

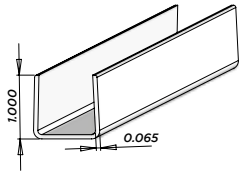

F83S (0.065 Wall)
7/8" U-Channel Standard

Pcs/Box: 64
AL - 10'2"
UT - 10'2"

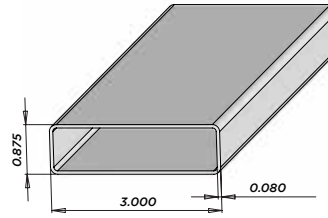

F57H (0.080 Wall)
7/8" X 3" Gorilla® Pickets

Pcs/Pallet: 355
AL - 16'
UT - 16'

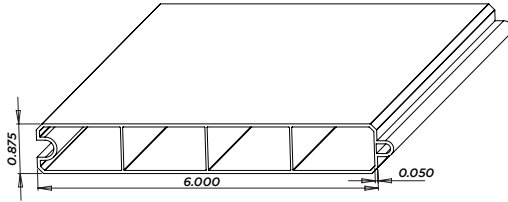

F54U (0.050 Wall)
7/8"x6" T&G Utility

Pcs/Pallet: 178 (16')
Shorter Lengths: 346
AL - 30-1/2", 60", 62-1/4", 64", 16'
UT - 30-1/2", 60-1/4", 62-1/4", 64", 16'

*O=Mocha Walnut, Y=Honey Maple, Q=Earl Gray, U=Green Teak (Q & U - Coming Soon)
Availability and profile dimensions are subject to change without notice. Check with manufacturer before ordering.
All dimensions are subject to manufacturer's tolerances.

Toll Free: (800) 999-6813



www.homelandvinyl.com

Rel. 15-131

HOMEWOOD® PROFILES

NEXUS® STYLE RAILS IN HOMEWOOD® FINISH

ALUMINUM INSERT REQUIRED IN ALL POCKET RAILS FOR HOMEWOOD SERIES.
RANCH RAIL REQUIRES AN ALUMINUM INSERT IN EACH RAIL.

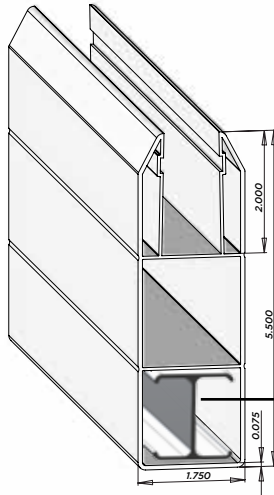

F3P5 1-3/4"x5-1/2"
Nexus® Pocket Rail
7/8" x 2" Deep

Pcs/Pallet: 98

**AL - 94" w/Aluminum Inserted,
16' (No Insert)**

Proper G32GP Aluminum
Insert Orientation Shown

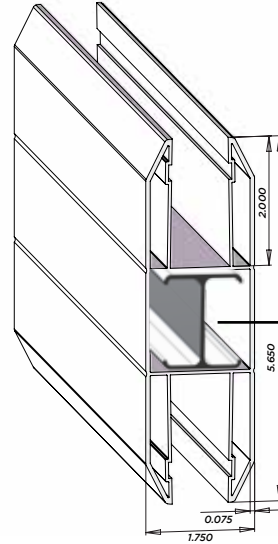

F3PM 1-3/4"x5-1/2"
Nexus® Mid-Rail
7/8" x 2" Deep

Pcs/Pallet: 98

**AL - 94" w/Aluminum Inserted,
16' (No Insert)**

**UT - 71-1/2" w/Aluminum Inserted,
16' (No Insert)**

Proper G32GP Aluminum
Insert Orientation Shown

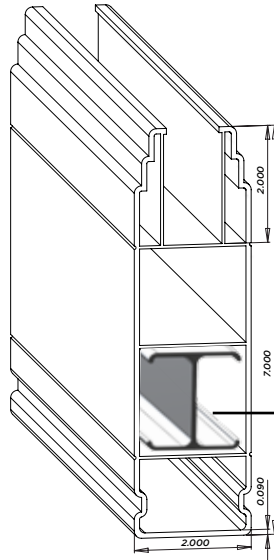

F3P2 2"x7"
Nexus® Pocket Rail
7/8" x 2" Deep

Pcs/Pallet: 66

**AL - 94" w/Aluminum Inserted,
16' (No Insert)**

**Special Order Only:
10 bundle minimum requirement**

Proper G3P2 Aluminum
Insert Orientation Shown

*O=Mocha Walnut, Y=Honey Maple, Q=Earl Gray, U=Green Teak (Q & U - Coming Soon)

Availability and profile dimensions are subject to change without notice. Check with manufacturer before ordering.
All dimensions are subject to manufacturer's tolerances.

Toll Free: (800) 999-6813



www.homelandvinyl.com

Rel. 15-131

HOMWOOD® PROFILES

RAILS IN HOMWOOD® FINISH

ALUMINUM INSERT REQUIRED IN ALL POCKET RAILS FOR HOMWOOD SERIES.
RANCH RAIL REQUIRES AN ALUMINUM INSERT IN EACH RAIL.

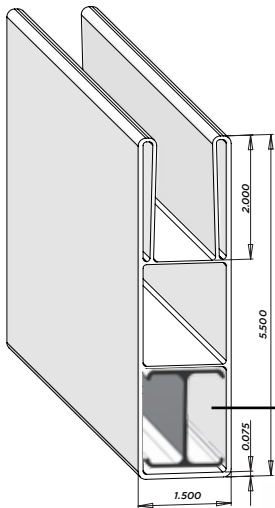

F32G 1-1/2"x5-1/2"
Gorilla® Pocket Rail
7/8" x 2" Deep

Pcs/Pallet: 114
AL - 94" w/Aluminum Inserted,
16' (No Insert)

UT - 71 1/2"
w/Aluminum Inserted,
16' (No Insert)

Proper G32GP Aluminum
Insert Orientation Shown

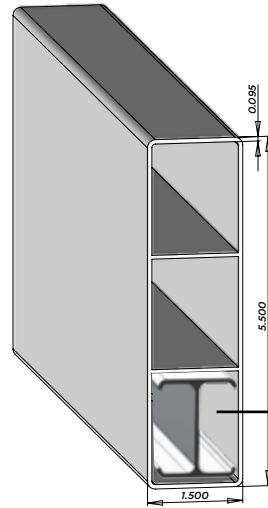

F27C (0.095 Wall)
1-1/2"x5-1/2"
Ribbed Rail

Pcs/Pallet: 114
AL - 16'
UT - 16'
Aluminum Insert
Required in Each Rail

Proper G32GP Aluminum
Insert Orientation Shown

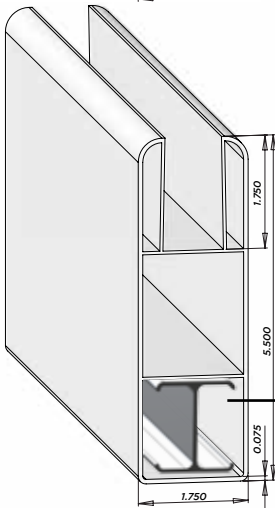

F37C 1-3/4"x5-1/2"
Gorilla® Pocket Rail
7/8" x 1 3/4" Deep

Pcs/Pallet: 98
UT - 71-1/2"
w/Aluminum Inserted,
16' (No Insert)

Proper G32GP Aluminum
Insert Orientation Shown

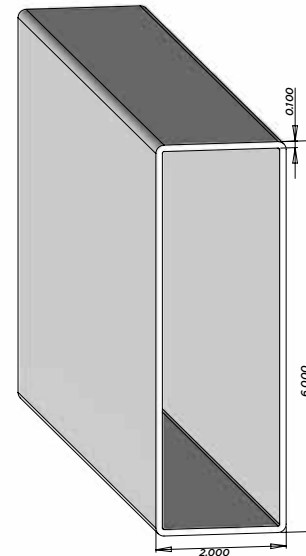

F22E 2"x6"
Hollow Rail

Pcs/Pallet: 88
AL - 16'
UT - 16'

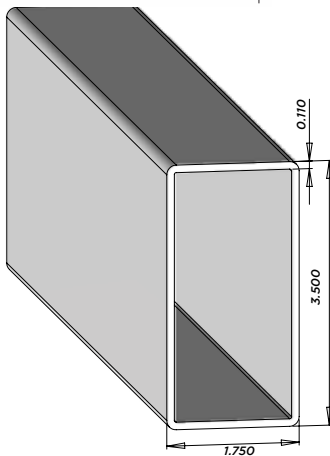

F25B (0.110 Wall)
1-3/4" x 3-1/2"
Hollow Standard Rail

Pcs/Pallet: 156
UT - 16'
AL - 16'

*O=Mocha Walnut, Y=Honey Maple, Q=Earl Gray, U=Green Teak (Q & U - Coming Soon)
Availability and profile dimensions are subject to change without notice. Check with manufacturer before ordering.
All dimensions are subject to manufacturer's tolerances.

ALUMINUM INSERTS

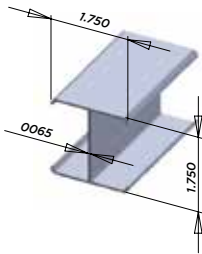

**Nexus® 2" x 7" Pocket Rail
I Insert**
G3P2093-7896

93" Lengths
250 Pieces per Bundle

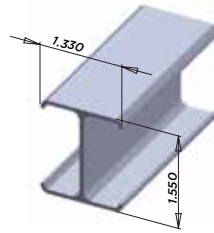

**1-1/2" x 5-1/2" Gorilla®
Pocket Rail Insert**
G32GP093-06505

AL - 93"
UT - 71"
300 Pieces per Bundle

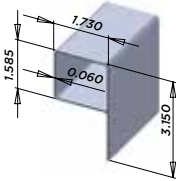

2" x 3-1/2" & T-Rail
G24PA288-69227

AL - 6', 8'
120 Pieces per Bundle

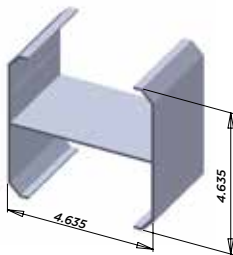

5" x 5"
G10HA288-69243

AL - 24'
Per Piece

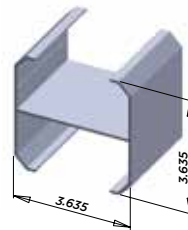

4" x 4"
G12HA288-69312

AL - 24'
Per Piece

*O=Mocha Walnut, Y=Honey Maple, Q=Earl Gray, U=Green Teak (Q & U - Coming Soon)
Availability and profile dimensions are subject to change without notice. Check with manufacturer before ordering.
All dimensions are subject to manufacturer's tolerances.